



M7 Longspan shelving

for medium and heavy loads





An optimum storage system for manual picking according to the 'person-to-goods' principle

Advantages

- **Store medium to heavy unit loads.**
- **Adjust multiple levels** by 25 or 50 mm, depending on how the system is set up.
- Shelves can be **up to 20 m high**.
- **Install one or more walkways** to access upper shelves.
- **Easy to assemble.**
- **Ultraportable.**
- A **wide range of components** adapt the shelves to your storage needs.





Basic structures



Three basic structures can be built from the different components. All three have vertical frames, which come in various profiles depending on the load to be supported.

Levels can be structured with:

- Beams and shelves.
- Reinforced shelves.
- Beams only.

Choosing one structure over another depends on the product to be stored, its dimensions and weight.

Standard dimensions:

H = from 1,000 to 8,000 (in multiples of 500 mm)

L = 1,000, 1,200, 1,400, 1,900, 2,300 and 2,700 mm

D = 500, 600, 800, 900, 1,000, 1,100 and 1,200 mm

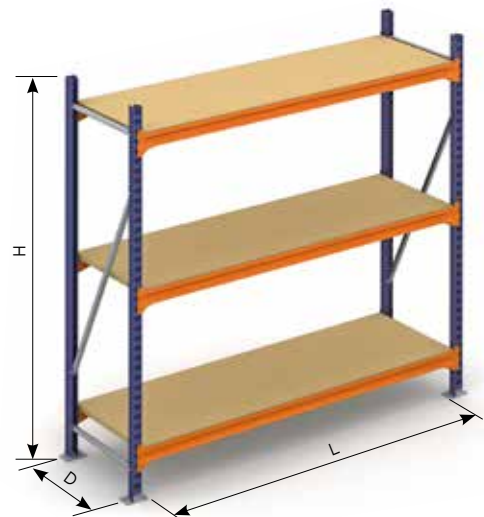



Beam-shelf storage levels

Each level has a minimum of two beams fitted with shelves or panels.

This system is the highly suited for:

- Boxes, packets or loose material.
- Heavy loads in medium-sized slots.
- Medium loads in large slots.
- Bulky products.

Beams fitted into the frames give the shelves the rigidity they need, in most cases. So, a basic rack only requires frames, beams and shelf panels. Shelf panels come in metal, chipboard or wire mesh.





Reinforced shelf storage levels

Shelves comprise heavy-duty single metal panels with reinforced edges. Reinforcement can also be fitted to enhance the shelf capacity.

The shelves are held in place by four supports fitted into the frames' side slots, which the corners of the shelf fit into.

This system is ideal for:

- Storing boxes, packets or loose material.
- Medium-sized slots to hold light or medium loads.
- Divided compartments made of vertical dividers or drawers.
- Creating three-sided enclosed storage spaces.
- Minimum height loss.

Lengthwise rigidity is achieved by vertical cross-braces fastened to the back of the racks.

This construction system is normally used with M3 shelving, but it is also used with M7 Longspan shelving when an application has an increased number of levels and a greater load capacity.





Beam only shelves

Certain products do not require shelves for storage purposes, such as:

- Hanging garments.
- Hanging samples.
- Tyres, wheels and rims.
- Long, rigid articles.

Different types of beams let you adapt the shelving to these products. The union between the beam and the uprights needs to be analysed to ensure the rigidity is sufficient, which in turn guarantees shelf stability.



The most commonly used modular systems are those made of beams and shelves, or of reinforced shelves.

The differences are shown in the next two drawings:

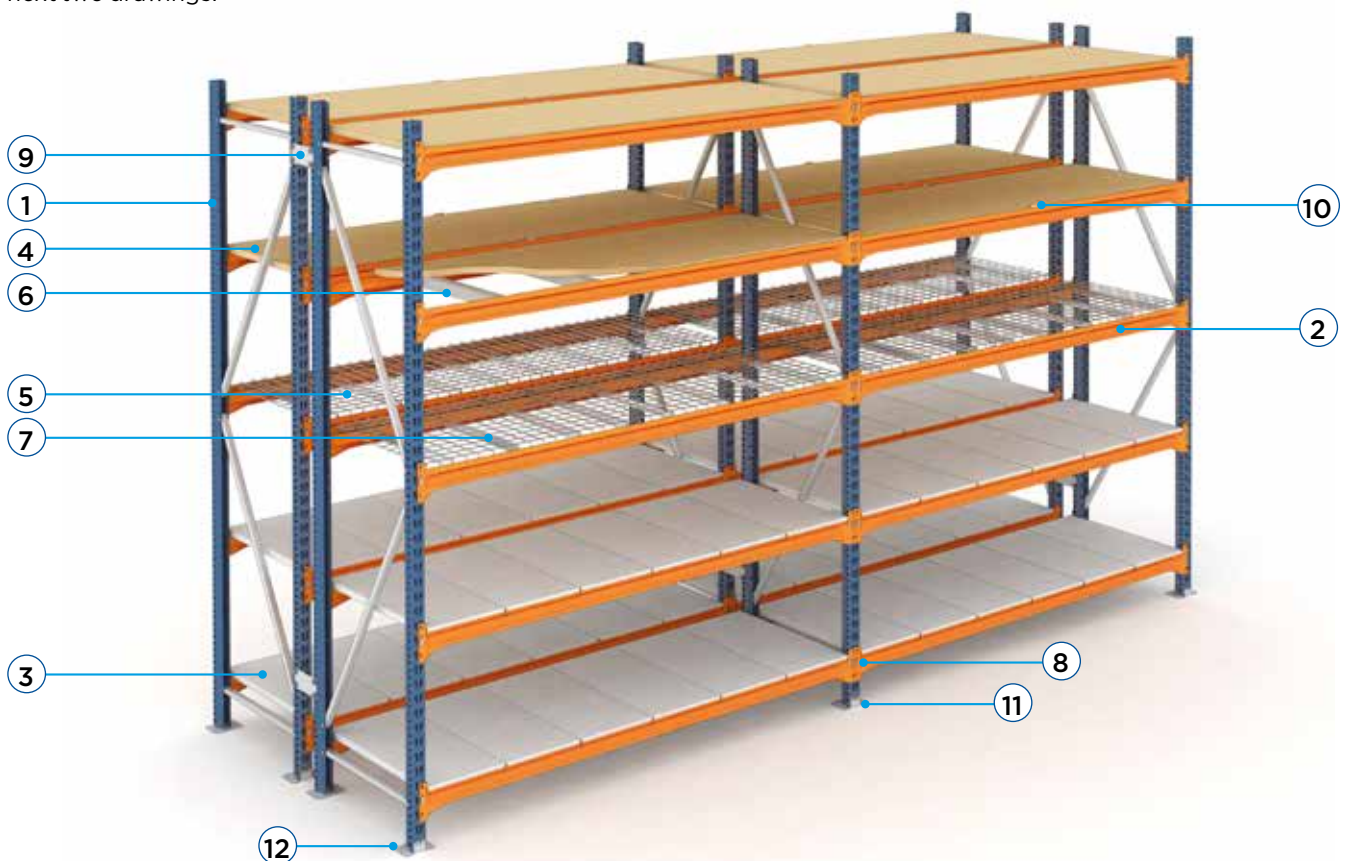

Basic components. Beam-shelf storage levels

- | | |
|-----------------------------|---------------------------------|
| 1. Frame | 8. Safety pins |
| 2. Beam | 9. Frame union |
| 3. Galvanised picking shelf | 10. Z-TAM Clamp |
| 4. Chipboard shelf | 11. Shim (levelling plate) |
| 5. Mesh shelf | 12. Anchor bolt (if applicable) |
| 6. Chipboard cross-tie | |
| 7. Mesh shelf cross-tie | |



Basic components. Reinforced shelves storage levels

- 13. Frame
- 14. HM Shelf
- 15. PK Shelf support
- 16. Vertical cross-bracing set
- 17. Shim (levelling plate)
- 18. Anchor bolt (if applicable)
- 19. Frame union

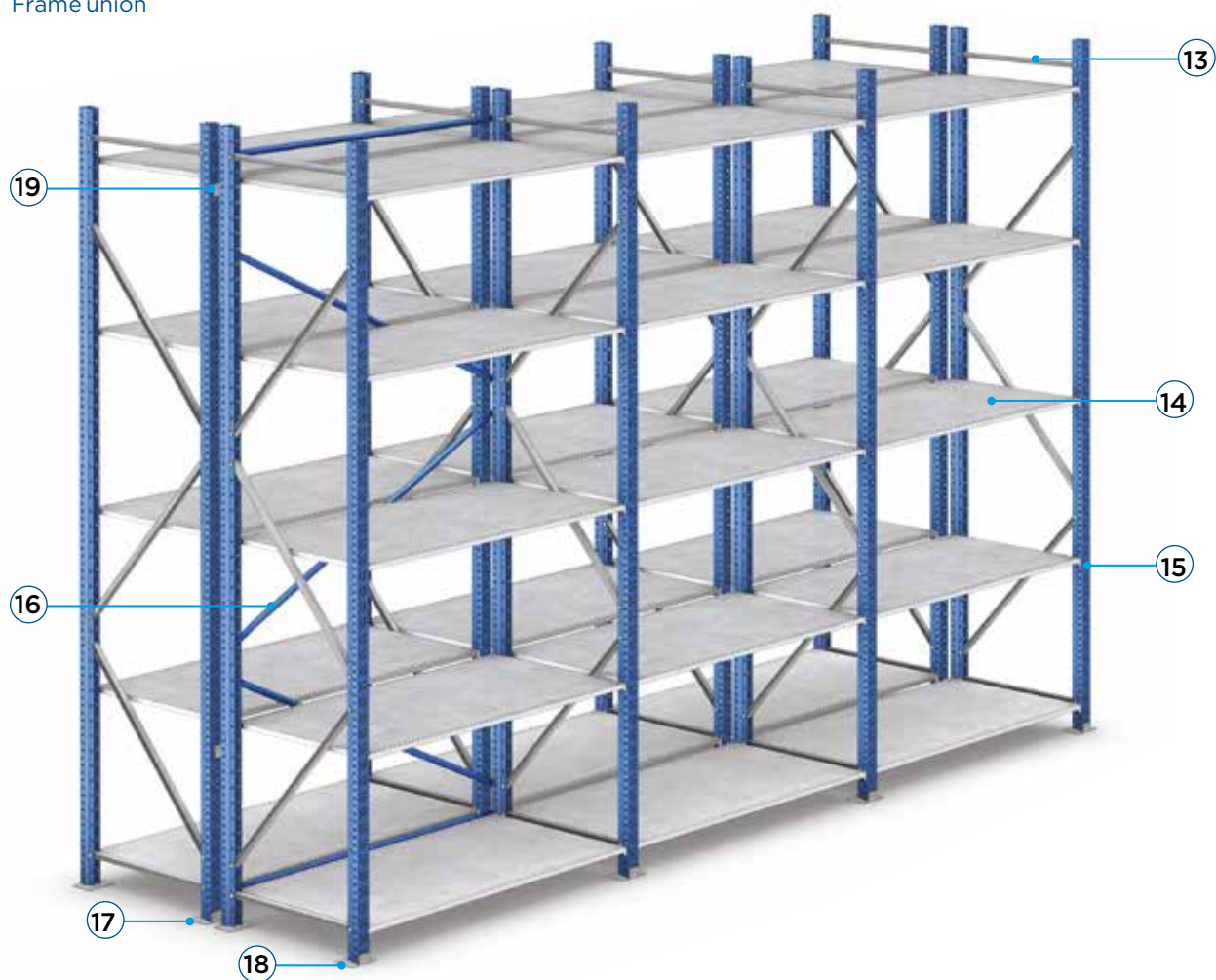



Basic components. Beam only storage level

1. Frame
2. MS Beam
3. Hanger beam
4. Shim (levelling plate)
5. Anchor bolt (if applicable)
6. Frame union
7. Safety pins

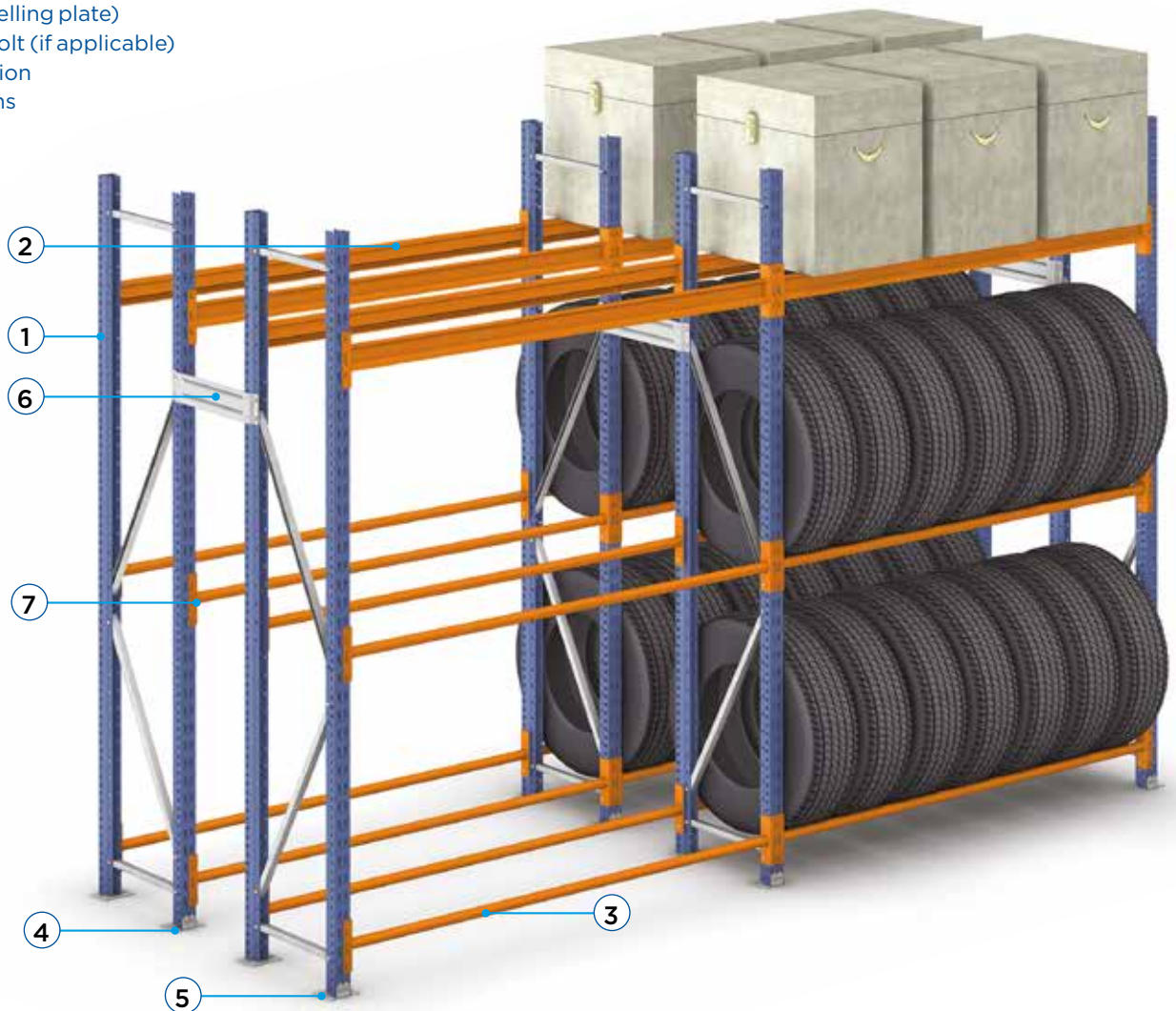



Units for hanging products

These shelves have two solutions for hanging garments or other articles. One is made of hanger tubes and another in which shelves are combined with supports and hanger tubes.

- 8. Frame
- 9. Hanger beam
- 10. Hanger tube support
- 11. Hanger tube
- 12. Support
- 13. Z Beam
- 14. Shelf
- 15. Safety pins
- 16. Shim
- 17. Anchor bolt (if applicable)

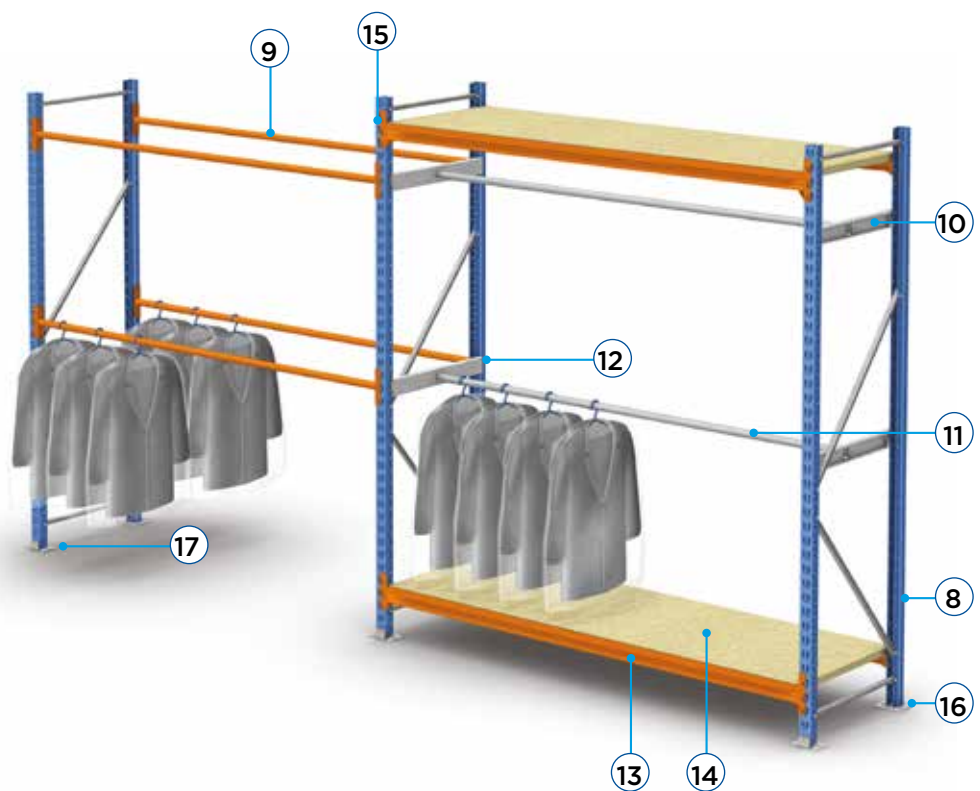

Components



Frames

Composed of two uprights, they include the corresponding bracings, footplates and accessories. The front of the frames is slotted every 50 mm, and 25 mm along the side, to fit HM shelves and other accessories.

Different depths enable the shelving to be adapted to the size of the product being stored.

Diverse upright models, lengths and thicknesses adjust easily to a variety of loads.



Profile models

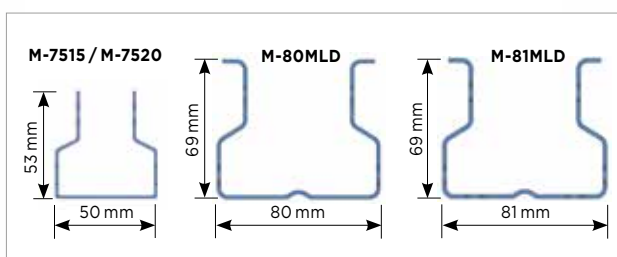



Frame footplates. The frames are fixed to the floor by means of footplates, which are placed on ends of the uprights. Different footplates are available depending on the upright model. Anchor bolts can be fitted to the shelving, when required.



Shims (levelling plates). Shims are used to level racks fitted on an irregular floor surface. Different plates are available for each upright and in various thicknesses to level the shelving with greater precision.



Anchor bolts. Different anchor bolts are used to fix the components to the floor, depending on the strain the shelves must bear and the floor's characteristics.

Components



Frame unions

Steel plates fixed to the uprights through the holes at their ends. Their function is to join the double shelves, giving them greater transversal stability.



Wall unions

Wall unions are used when single racks need to be joined to walls.



Frame splice

When single-piece frame uprights cannot be placed due to an installation's height, splices are bolted inside the upright.





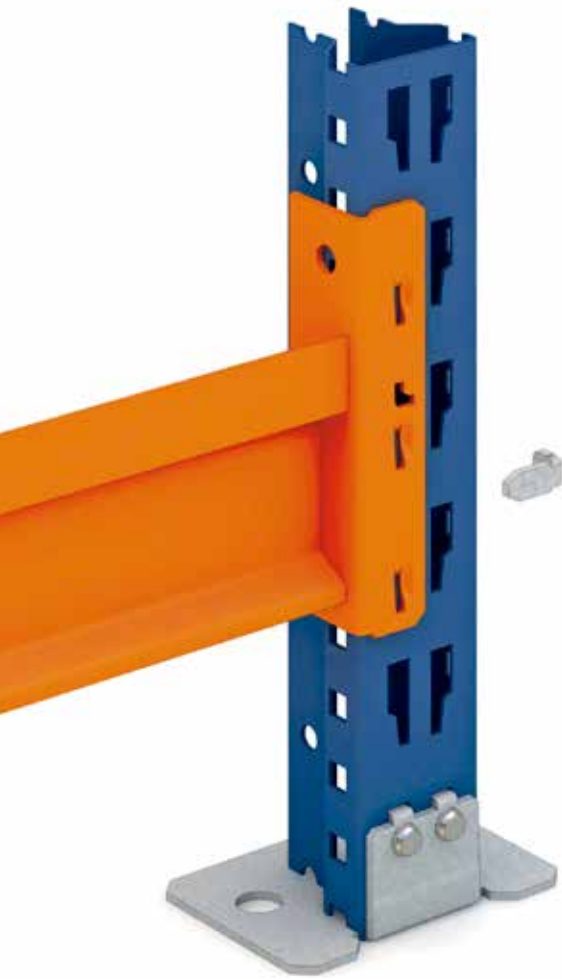

Beams

The beams are the horizontal components where loads are deposited or where shelves are placed to store small-sized products. They are joined to the uprights by connectors or clips, which slide into the uprights' slots. The connector's hooks –a system developed and patented by Mecalux– fit into the main frame at both ends, which considerably increases the load capacity. Each beam includes two safety pins.

Mecalux has an extensive range of beams, which covers any storage need in terms of size, load type and capacity.

Safety pins

These pins prevent the accidental displacement of the beams.



Two types of beams are available:

Stamped beams

The connectors are formed by stamping the ends of the pre-shaped profiles. This system -developed and patented by Mecalux- enables one-piece manufacturing, to avoid welded joints and, thus, provide an unbeatable load transmission.

These beams are Z-shaped, with an upper vertical flange to hold and secure the shelves. The standard models include ZE-35, ZE-55 and ZE-65.



Welded beams

This is the classic, universal system in which profiles are welded to the connectors at the beam ends. Welding is done in cases where, due to the size or specific applications, it is required for the storage system. The most commonly used are: ZS-35, ZS-55 and ZS-65 beams.



Beams
ZS-35, ZS-55, ZS-65



MS-65 beams
Use this piece when a shelf protrudes from the module.



Hanger or garment beams
Use this solution to hang garments or other articles, or to support cylindrical objects.

Optional components



Galvanised picking shelves

The most frequent combination is to fit metal shelves with Z beams.

A storage level is composed of various shelves of different widths, depending on the level's length and the weight of the product stored.

The shelves rest on the beams, fitted into the vertical flange, which enables the two beams of a single level to stay joined together. All of this gives the shelving greater rigidity.

The shelves of each level fit perfectly into each other, thanks to indentations and lateral slots.



Picking shelf dividers

Fit these vertical metallic dividers between an upper and lower storage shelf to create cubicles on a certain level. They can be moved from side to side, enabling you to adjust the size of the storage space.

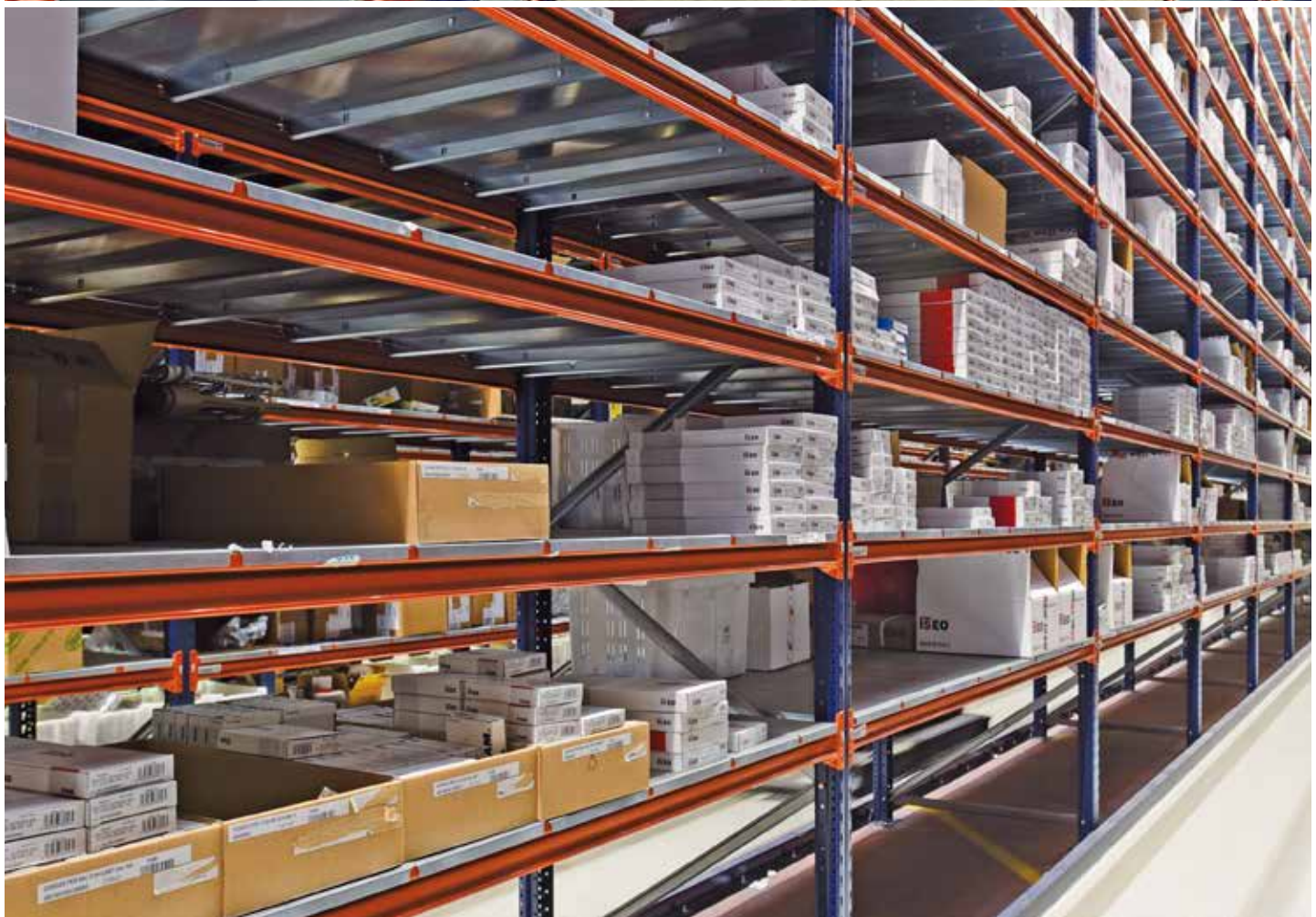

Optional components



Chipboard shelves

Fitted between two ZE or ZS beams, the panel's front edge is concealed by the vertical edge of the beams.

Cross-ties can be added depending on the load.

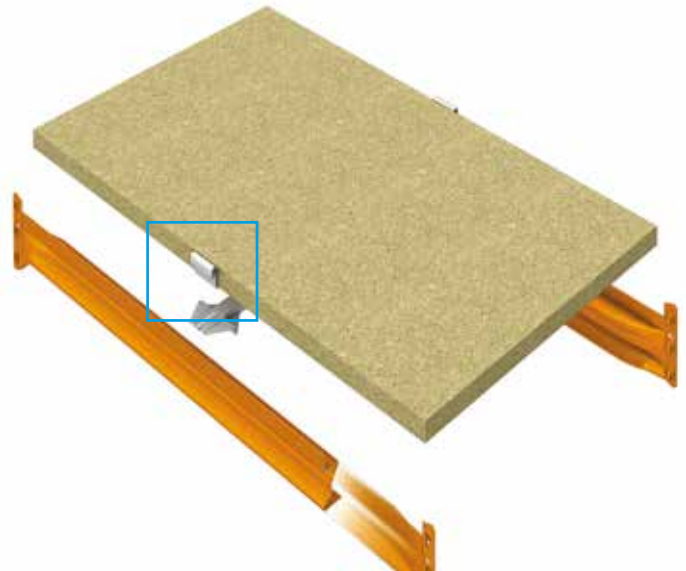

L-Z Cross-ties

Use these metal pieces, which are stamped at each end, to ensure proper support on the beams.

They increase the load capacity of the chipboard shelves.

They rest on two beams of the same storage level, underneath the chipboard shelf. The number used varies depending on the load to be supported.



Z-TAM Clamps

In levels equal or greater than 1,900 mm, use these clamps to keep the two beams flush with the chipboard shelf and to give the unit more rigidity.



Optional components

Double-depth chipboard shelving

When a storage level is very deep and the shelf a single, long piece, the unit must be assembled as shown in the illustration below. In other words, place ZE or ZS beams at the ends and MS beams in the centre.



Vertical chipboard dividers

Use these to form smaller slots on the same storage level. They are manufactured in plain chipboard finish.

Two upper and two lower clamps are required to fit them to their respective shelves.



Shelving with chipboard dividers



Mesh shelves

Formed by rectangular electro-welded mesh pieces, these pieces are also welded onto mesh cross-ties to give the unit greater rigidity.

These shelves rest on ZE or ZS beams. Together, the two parts create a level area and strengthen the unit.

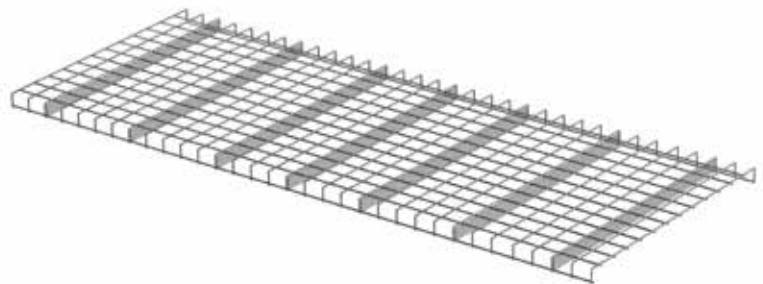

Close-up of mesh shelving

HM Shelves



Storage levels can be made just from HM shelves, without needing to fit any beams. The shelves used are supported on each corner by four picking shelf supports, which are fitted into the slots of the uprights beforehand.

HM shelves are manufactured in a single piece of galvanised sheeting, formed by several folds, giving the shelf a greater load capacity both at the front and the side.

The shelves come with slots punched above and below, which enable dividers and accessories to be fitted.

Standard sizes include:

L = 1,000, 1,250 and 1,400 mm

D = 300, 400, 500 and 600 mm

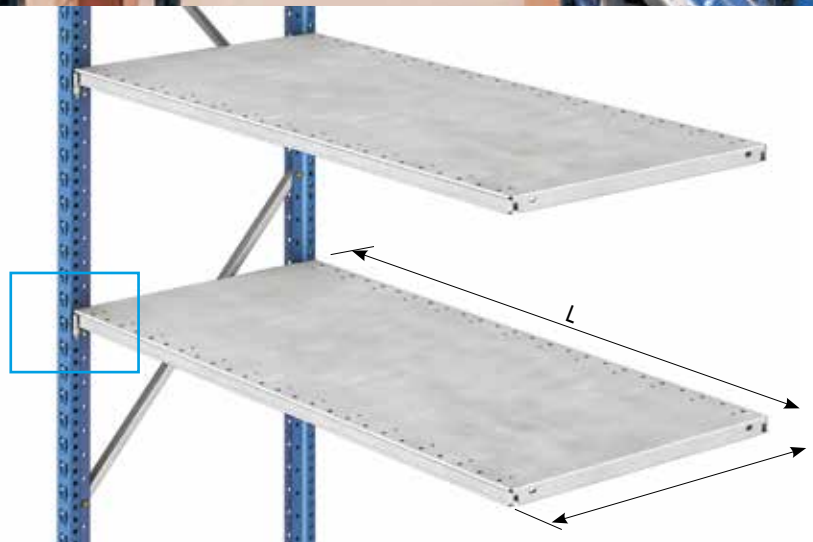

The groove along the front part serves as a label support or as a magnetic label holder.



Shelf reinforcement

The HM shelves can be fitted with a lengthwise central reinforcer to increase load capacity.



HD Beams

The basic function of these beams is to increase the lengthwise rigidity and stability in very tall shelving units built with HM shelf storage levels.

In addition, they can be used to raise the load capacity of the shelves.



Vertical cross bracing

Shelving units comprised of HM shelf panels require these braces, to guarantee lengthwise stability.

Tubular profiles with specially shaped ends, these braces are bolted to the front slots of the uprights. The number of braced units depends on the length and height of the shelving units, as well as the weight of the stored product.

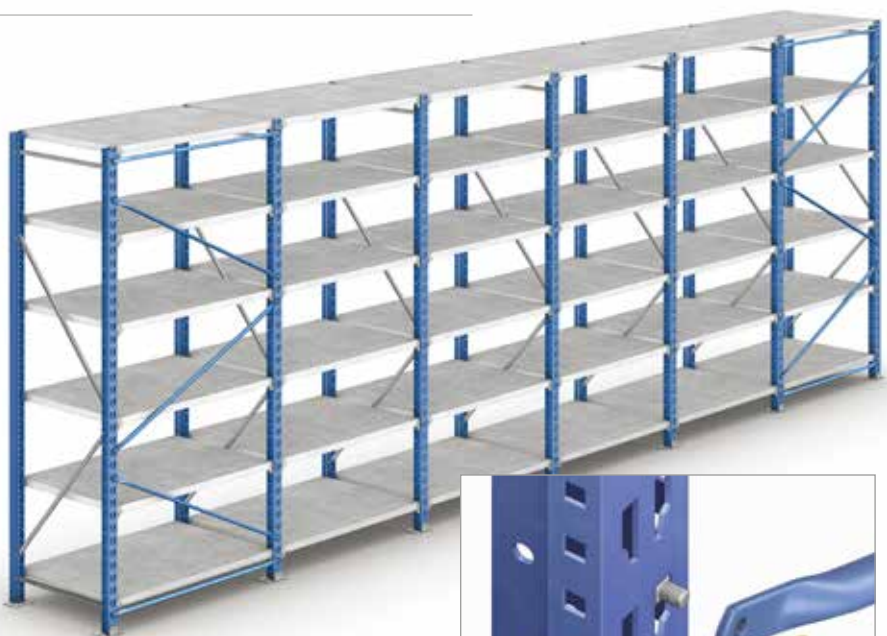

Back view



Cross bracing union



Slotted shelf dividers

Use these vertical separators to enable compartments in the storage levels made of HM shelves.

They are fixed into the slots of the shelves and can be fitted in two different ways:

- By fixing them to the top and bottom shelf, thus dividing the total height.
- By only fixing them to the bottom shelf.





Hanger tubes

Either one or two tubes fit into the hanger tube supports. The set rests on four PK supports, which have been previously hooked into the inner slots of the uprights.

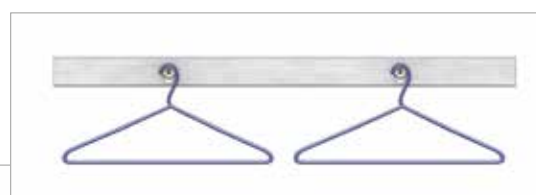
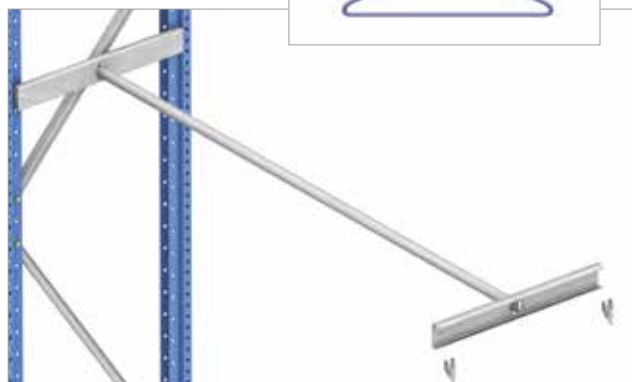

Single hanger tubes are used to hang products or items such as garments.

Double hanger tubes can also be used to hang products, or to support cylindrical objects such as tyres.

Optional components



Side and rear mesh

Mesh panels can be fitted to the side of the shelving unit to prevent products from falling or from mixing with products from other levels.

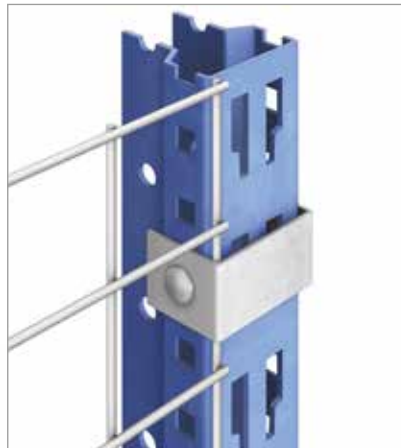

Likewise, mesh panels can also be attached to the rear of the shelf for the same purpose.

Mesh is fixed to the uprights using PK clamps.



Back view





Chipboard side panels

Frames can also be assembled with uprights and chipboard side panels to prevent the stored goods from falling or from mixing with other levels.



Accessories



Magnetic label holders

These magnetised plastic profiles are fitted to the front of the HM shelves to label or indicate the levels or the compartments in the levels, or to identify the products stored. They are fitted into the front groove of the shelves. Two models are available:

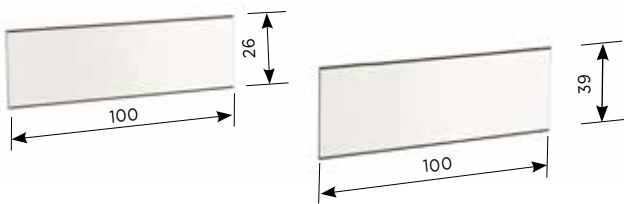

Model A

The front surface is finished in white plastic, which enables it to be written on with a permanent marker pen.

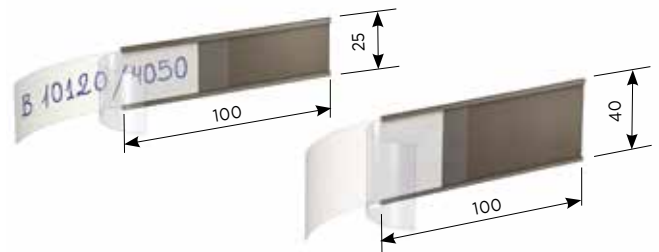

Model B

Use this double-edged sleeve to hold a changeable, same-width label. The label is protected by a plastic cover, which slides over the label into the same holder.



Signs

Use these rectangular plaques fitted at the shelf ends to identify areas with either letters or numbers.

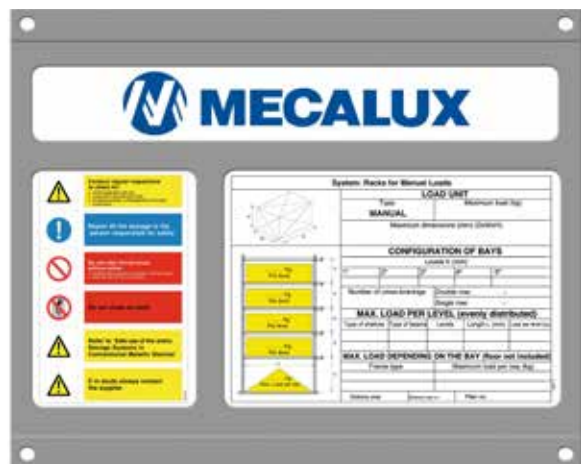

Signalling plates

These boards list the technical characteristics of the installation. They are visibly displayed at the end of the shelves.

Other solutions, which are not mentioned in this catalogue, can be combined and implemented with this system after careful consideration of a customer's storage needs.



e-mail: romania@mecalux.com - mecalux.ro

MECALUX ROMÂNIA

BUCUREȘTI

Tel. +40 753 098 246

River Plaza

Intrarea Nestorei nr.1, Sector 4

București

Mecalux este prezent în peste 70 de țări din întreaga lume

Reprezentanțe în: Argentina - Belgia - Brazilia - Canada - Cehia - Chile - Columbia - Croația - Franța - Germania - Italia
Mexic - Olanda - Polonia - Portugalia - Regatul Unit - România - Slovacia - Slovenia - Spania - SUA - Turcia - Uruguay

